

# Microkernel Construction

Kernel Entry / Exit

Nils Asmussen

05/04/2017

- x86 Details
  - Protection Facilities
  - Interrupts and Exceptions
  - Instructions for Entry/Exit
- Entering NOVA
- Leaving NOVA

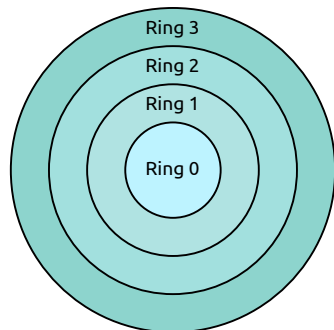

- Ring 0
  - Operating System Kernel
  - Privileged
- Ring 1 & 2
  - Operating System Services
  - Unprivileged
- Ring 3
  - User-level Applications
  - Unprivileged

- Segmentation
  - Mechanism for dividing linear address space into segments
  - Different segment types: code, data, stack, ...
  - Segment has base address and limit
  - Mandatory mechanism; cannot be disabled
- Paging
  - Mechanism for translating linear to physical addresses
  - Splits virt. & phys. address space into same-size pages
  - Per-page access rights (present, writable, user/kernel)
  - Optional; can be turned off (not on x86\_64)

- Logical address consists of
  - Segment selector
  - Segment offset
- CPU uses table indicator in segment selector to access descriptor in GDT/LDT
- Segment descriptor provides segment base address, segment limit and access rights (checked by CPU)
- CPU adds segment offset to segment base address to form linear address

# Logical Address Translation

Logical Address:

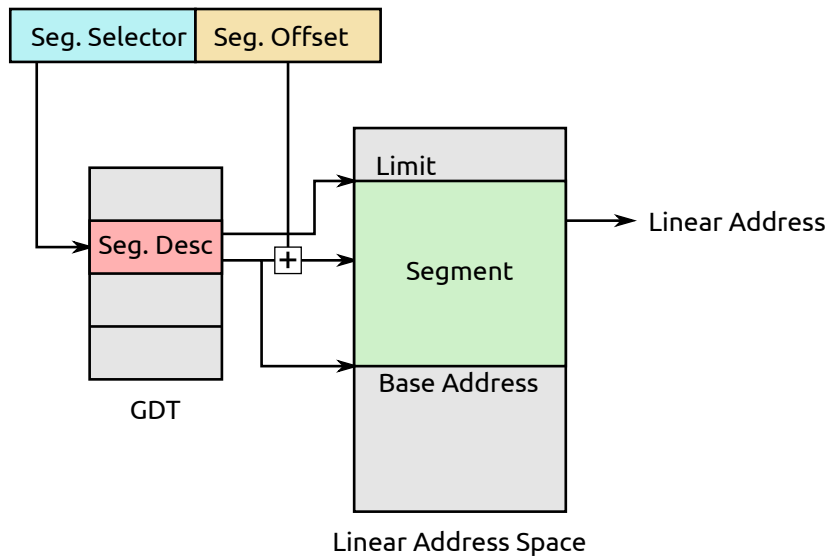

- CPU provides 6 segment registers for holding selectors
  - CS (code segment)
  - DS (data segment)
  - SS (stack segment)
  - ES, FS, GS (extra data segments)
- Selector forms visible part
- Base address, limit and access rights form shadow part

# Segment Descriptor

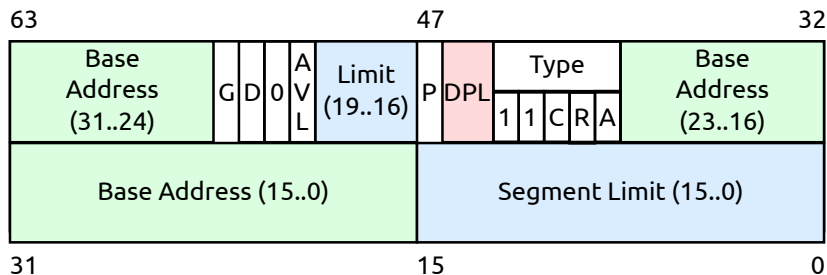

Figure: Code Segment Descriptor

<b>G</b>	Granularity	<b>DPL</b>	Descriptor Privilege Level
<b>D</b>	Default Size (16/32 Bit)	<b>C</b>	Conforming
<b>AVL</b>	Available to Programmer	<b>R</b>	Readable
<b>P</b>	Present	<b>A</b>	Accessed



- Hide segmentation mechanism by
  - Setting segment base address to 0
  - Setting segment limit to 4 GiB
- Mandatory for x86\_64
- We need at least 2 segments
  - Code segment
  - Data/Stack segment
- If kernel/user use different segment base addresses or segment limits, we need 2 additional segments for each

- CPU checks on instructions and memory references that certain protection conditions hold:
  - Segment limit check
  - Segment type check
  - Privilege level check
  - Restricted procedure entry points
  - Restricted instruction set
  - ...
- CPU raises exception if protection check fails
- Protection checks in parallel with address translation
- No big performance penalty

- LGDT
- LLDT
- LTR
- LIDT
- MOV to CR
- LMSW
- CLTS
- MOV to DR
- INVD
- WBINVD
- INVLPG
- HLT
- RDMSR / WRMSR
- RDPMC / RDTSC
- CLI / STI

- Forced transfer of execution from currently executing code to interrupt- or exception handler
- Hardware interrupts occur asynchronously in response to hardware events
- Exceptions (including software interrupts) occur synchronously to the instruction stream

- Vector uniquely identifies source of the interrupt or exception
  - Vectors 0 .. 31 are used for exceptions
  - Vectors 32 .. 255 are designated user vectors (e.g., interrupts)
- Interrupt Descriptor Table (IDT) is table of handler functions for all interrupts and exceptions
  - Setup by OS
  - Hardware is informed about it via LIDT instruction
  - Vector = offset into IDT

# Interrupt Descriptor Table (IDT)

IDTR register:

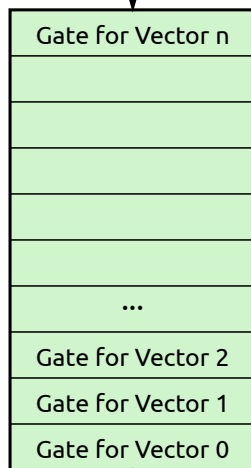
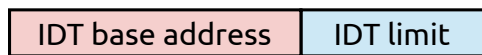

- Descriptors to call procedures at different privilege levels
  - Subject to CPL/RPL vs. DPL checking
  - CS and EIP loaded from descriptor
  - Interrupt Gate disables interrupts, Trap Gate doesn't
- When switching privilege levels, new ESP loaded from TSS
  - TSS contains stack pointers for privilege levels 0, 1 and 2
  - Kernel updates  $SP_0$  in TSS on every thread switch
  - Interrupt and exception handlers runs current thread's context

# Interrupt Gate

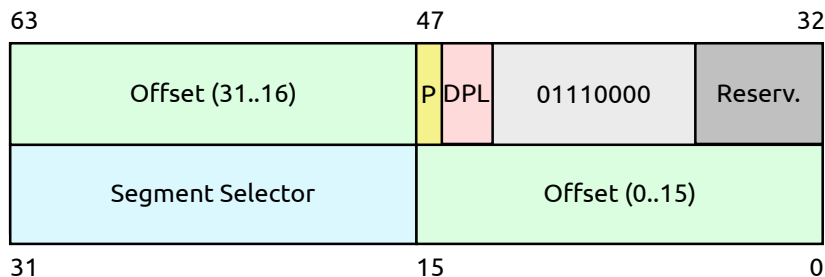

- Selector** Segment Selector for destination code segment  
**Offset** Offset to procedure entry point in segment  
**DPL** Descriptor privilege level (ignored for HW ints)  
**P** Segment present flag



- Faults
  - Can be corrected and allow the program to be resumed
  - Processor restores machine state prior to the execution of faulting instruction (CS and EIP point to faulting instruction)
- Traps
  - Reported immediately after execution of trapping instruction
  - Allow the program to be resumed (CS and EIP point to following instruction)
- Aborts
  - Are not always reported at the precise location of the exception
  - Do not allow to resume the program
  - Usually report severe hardware errors or inconsistent state

- 0: Divide Error (F)
- 1: Debug Exception (F/T)
- 2: Non-maskable Interrupt
- 3: Breakpoint (T)
- 4: Overflow (T)
- 5: Bound Range Exc. (F)
- 6: Invalid Opcode (F)
- 7: Device Not Available (F)
- 8: Double Fault (A)
- 9: Coproc. Seg. Overr. (F)
- 10: Invalid TSS (F)
- 11: Segm. Not Present (F)
- 12: Stack Segment Fault (F)
- 13: General Prot. Fault (F)
- 14: Pagefault (F)
- 15: *reserved*
- 16: FPU Math Fault (F)
- 17: Alignment Check (F)
- 18: Machine Check (A)
- 19: SIMD FP Exception (F)

# Kernel Stack after Kernel Entry

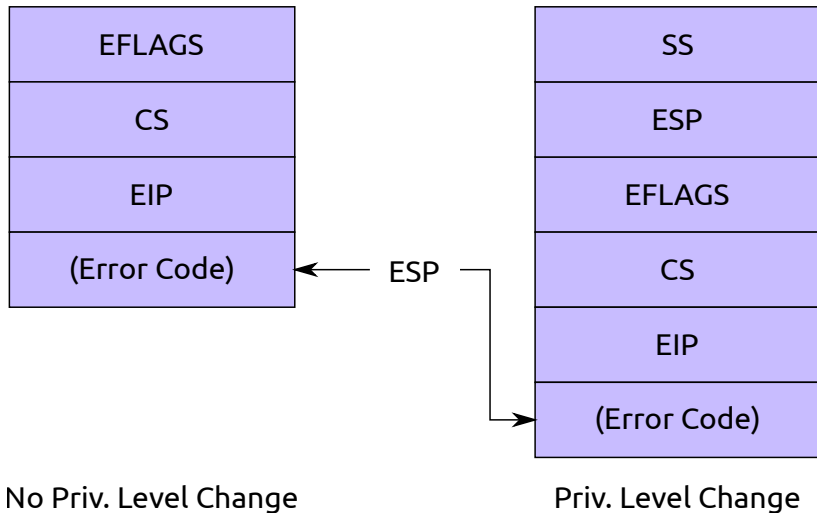

# Kernel Entry

SS
ESP
EFLAGS
CS
EIP

```
entry_6:          push $6
                  jmp  entry_exc

entry_exc:        push $0
entry_exc_err:   push %ds
                  push %es
                  push %fs
                  push %gs
                  pusha

                  mov %esp, %ebx
                  mov $KSTCK_BEGIN, %esp
                  mov %cr2, %eax
                  mov %eax, 0xc(%ebx)
                  mov %ebx, %eax
                  call exc_handler

                  jmp  ret_from_interrupt
```

# Kernel Entry

SS
ESP
EFLAGS
CS
EIP
Vector=6

```
entry_6:          push $6
                  jmp  entry_exc

entry_exc:        push $0
entry_exc_err:   push %ds
                  push %es
                  push %fs
                  push %gs
                  pusha

                  mov %esp, %ebx
                  mov $KSTCK_BEGIN, %esp
                  mov %cr2, %eax
                  mov %eax, 0xc(%ebx)
                  mov %ebx, %eax
                  call exc_handler

                  jmp  ret_from_interrupt
```

# Kernel Entry

SS
ESP
EFLAGS
CS
EIP
Vector=6
Error=0

```
entry_6:          push $6
                  jmp  entry_exc

entry_exc:        push $0
entry_exc_err:    push %ds
                  push %es
                  push %fs
                  push %gs
                  pusha

                  mov %esp, %ebx
                  mov $KSTCK_BEGIN, %esp
                  mov %cr2, %eax
                  mov %eax, 0xc(%ebx)
                  mov %ebx, %eax
                  call exc_handler

                  jmp  ret_from_interrupt
```

# Kernel Entry

SS
ESP
EFLAGS
CS
EIP
Vector=6
Error=0
DS
ES
FS
GS

```
entry_6:          push $6
                  jmp  entry_exc

entry_exc:        push $0
entry_exc_err:    push %ds
                  push %es
                  push %fs
                  push %gs
                  pusha

                  mov %esp, %ebx
                  mov $KSTCK_BEGIN, %esp
                  mov %cr2, %eax
                  mov %eax, 0xc(%ebx)
                  mov %ebx, %eax
                  call exc_handler

                  jmp  ret_from_interrupt
```

# Kernel Entry

SS
ESP
EFLAGS
CS
EIP
Vector=6
Error=0
DS
ES
FS
GS
GPR (eax, ecx, edx, ebx, cr2, ...)

```
entry_6:          push $6
                  jmp  entry_exc

entry_exc:        push $0
entry_exc_err:    push %ds
                  push %es
                  push %fs
                  push %gs
                  pusha

                  mov %esp, %ebx
                  mov $KSTCK_BEGIN, %esp
                  mov %cr2, %eax
                  mov %eax, 0xc(%ebx)
                  mov %ebx, %eax
                  call exc_handler

                  jmp  ret_from_interrupt
```



# Kernel Entry

SS
ESP
EFLAGS
CS
EIP
Vector=6
Error=0
DS
ES
FS
GS
GPR (eax, ecx, edx, ebx, cr2, ...)

```
entry_6:          push $6
                  jmp  entry_exc

entry_exc:        push $0
entry_exc_err:   push %ds
                  push %es
                  push %fs
                  push %gs
                  pusha

                  mov %esp, %ebx
                  mov $KSTCK_BEGIN, %esp
                  mov %cr2, %eax
                  mov %eax, 0xc(%ebx)
                  mov %ebx, %eax
                  call exc_handler

                  jmp  ret_from_interrupt
```

# Kernel Entry

SS
ESP
EFLAGS
CS
EIP
Vector=6
Error=0
DS
ES
FS
GS
GPR (eax, ecx, edx, ebx, cr2, ...)

```
entry_6:          push $6
                  jmp  entry_exc

entry_exc:        push $0
entry_exc_err:   push %ds
                  push %es
                  push %fs
                  push %gs
                  pusha

                  mov %esp, %ebx
                  mov $KSTCK_BEGIN, %esp
                  mov %cr2, %eax
                  mov %eax, 0xc(%ebx)
                  mov %ebx, %eax
                  call exc_handler

                  jmp  ret_from_interrupt
```

# Exception Handler

```
REGPARAM(1) void exc_handler (Exc_regs *r) {
    switch (r->vec) {
        case Cpu::EXC_TS:
            handle_exc_ts (r);
            break;
        case Cpu::EXC_PF:
            handle_exc_pf (r);
            break;
        ...
    }
}

void handle_exc_pf (Exc_regs *r) {
    mword addr = r->cr2;
    if(Pd::current->Space_mem::loc[Cpu::id].sync_from (
        Pd::current->Space_mem::hpt, addr))
        return;
    ...
}
```

# Kernel Exit to Kernel Mode

SS
ESP
EFLAGS
CS
EIP
Vector=6
Error=0
DS
ES
FS
GS
GPR (eax, ecx, edx, ebx, cr2, ...)

...

```
mov %esp, %ebx
mov $KSTCK_BEGIN, %esp
mov %cr2, %eax
mov %eax, 0xc(%ebx)
mov %ebx, %eax
call exc_handler
```

```
jmp ret_from_interrupt
```

```
ret_from_interrupt:
```

```
testb $3, 0x3c(%ebx)
jnz ret_user_iret
popa
add $24, %esp
iret
```

# Kernel Exit to Kernel Mode

SS
ESP
EFLAGS
CS
EIP
Vector=6
Error=0
DS
ES
FS
GS
GPR (eax, ecx, edx, ebx, cr2, ...)

...

```
mov %esp, %ebx
mov $KSTCK_BEGIN, %esp
mov %cr2, %eax
mov %eax, 0xc(%ebx)
mov %ebx, %eax
call exc_handler
```

```
jmp ret_from_interrupt
```

```
ret_from_interrupt:
```

```
testb $3, 0x3c(%ebx)
jnz ret_user_iret
popa
add $24, %esp
iret
```

# Kernel Exit to Kernel Mode

SS
ESP
EFLAGS
CS
EIP
Vector=6
Error=0
DS
ES
FS
GS
GPR (eax, ecx, edx, ebx, cr2, ...)

```
...  
mov %esp, %ebx  
mov $KSTCK_BEGIN, %esp  
mov %cr2, %eax  
mov %eax, 0xc(%ebx)  
mov %ebx, %eax  
call exc_handler  
  
jmp ret_from_interrupt  
  
ret_from_interrupt:  
testb $3, 0x3c(%ebx)  
jnz ret_user_iret  
popa  
add $24, %esp  
iret
```

# Kernel Exit to Kernel Mode

SS
ESP
EFLAGS
CS
EIP
Vector=6
Error=0
DS
ES
FS
GS

...

```
mov %esp, %ebx
mov $KSTCK_BEGIN, %esp
mov %cr2, %eax
mov %eax, 0xc(%ebx)
mov %ebx, %eax
call exc_handler
```

```
jmp ret_from_interrupt
```

```
ret_from_interrupt:
```

```
testb $3, 0x3c(%ebx)
jnz ret_user_iret
popa
add $24, %esp
iret
```

# Kernel Exit to Kernel Mode

SS
ESP
EFLAGS
CS
EIP

...

```
mov %esp, %ebx
mov $KSTCK_BEGIN, %esp
mov %cr2, %eax
mov %eax, 0xc(%ebx)
mov %ebx, %eax
call exc_handler
```

```
jmp ret_from_interrupt
```

```
ret_from_interrupt:
```

```
testb $3, 0x3c(%ebx)
jnz ret_user_iret
popa
add $24, %esp
iret
```



## Kernel Exit to Kernel Mode

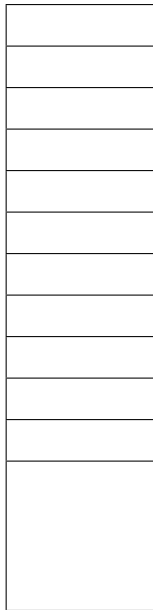

```
...  
mov %esp, %ebx  
mov $KSTCK_BEGIN, %esp  
mov %cr2, %eax  
mov %eax, 0xc(%ebx)  
mov %ebx, %eax  
call exc_handler
```

```
jmp ret_from_interrupt
```

```
ret_from_interrupt:
```

```
testb $3, 0x3c(%ebx)  
jnz ret_user_iret  
popa  
add $24, %esp  
iret
```

# Kernel Exit to User Mode

SS
ESP
EFLAGS
CS
EIP
Vector=6
Error=0
DS
ES
FS
GS
GPR (eax, ecx, edx, ebx, cr2, ...)

```
...  
mov %esp, %ebx  
mov $KSTCK_BEGIN, %esp  
mov %cr2, %eax  
mov %eax, 0xc(%ebx)  
mov %ebx, %eax  
call exc_handler
```

```
jmp ret_from_interrupt
```

```
ret_from_interrupt:  
testb $3, 0x3c(%ebx)  
jnz ret_user_iret  
popa  
add $24, %esp  
iret
```

# Kernel Exit to User Mode

SS
ESP
EFLAGS
CS
EIP
Vector=6
Error=0
DS
ES
FS
GS
GPR (eax, ecx, edx, ebx, cr2, ...)

```
void ret_user_iret() {
    handle_hazards();

    asm volatile (
        "lea %0, %%esp;"
        "popa;"
        "pop %%gs;"
        "pop %%fs;"
        "pop %%es;"
        "pop %%ds;"
        "add $8, %%esp;"
        "iret;"
        : : "m" (current->regs) : "memory"
    );
    UNREACHED;
}
```

# Kernel Exit to User Mode

SS
ESP
EFLAGS
CS
EIP
Vector=6
Error=0
DS
ES
FS
GS
GPR (eax, ecx, edx, ebx, cr2, ...)

```
void ret_user_iret() {
    handle_hazards();

    asm volatile (
        "lea %0, %%esp;"
        "popa;"
        "pop %%gs;"
        "pop %%fs;"
        "pop %%es;"
        "pop %%ds;"
        "add $8, %%esp;"
        "iret;"
        : : "m" (current->regs) : "memory"
    );
    UNREACHED;
}
```

# Kernel Exit to User Mode

SS
ESP
EFLAGS
CS
EIP
Vector=6
Error=0
DS
ES
FS
GS
GPR (eax, ecx, edx, ebx, cr2, ...)

```
void ret_user_iret() {
    handle_hazards();

    asm volatile (
        "lea %0, %%esp;"
        "popa;"
        "pop %%gs;"
        "pop %%fs;"
        "pop %%es;"
        "pop %%ds;"
        "add $8, %%esp;"
        "iret;"
        : : "m" (current->regs) : "memory"
    );
    UNREACHED;
}
```

# Kernel Exit to User Mode

SS
ESP
EFLAGS
CS
EIP
Vector=6
Error=0
DS
ES
FS
GS

```
void ret_user_iret() {
    handle_hazards();

    asm volatile (
        "lea %0, %%esp;"
        "popa;"
        "pop %%gs;"
        "pop %%fs;"
        "pop %%es;"
        "pop %%ds;"
        "add $8, %%esp;"
        "iret;"
        : : "m" (current->regs) : "memory"
    );
    UNREACHED;
}
```

# Kernel Exit to User Mode

SS
ESP
EFLAGS
CS
EIP
Vector=6
Error=0

```
void ret_user_iret() {
    handle_hazards();

    asm volatile (
        "lea %0, %%esp;"
        "popa;"
        "pop %%gs;"
        "pop %%fs;"
        "pop %%es;"
        "pop %%ds;"
        "add $8, %%esp;"
        "iret;"
        : : "m" (current->regs) : "memory"
    );
    UNREACHED;
}
```

# Kernel Exit to User Mode

SS
ESP
EFLAGS
CS
EIP

```
void ret_user_iret() {
    handle_hazards();

    asm volatile (
        "lea %0, %%esp;"
        "popa;"
        "pop %%gs;"
        "pop %%fs;"
        "pop %%es;"
        "pop %%ds;"
        "add $8, %%esp;"
        "iret;"
        : : "m" (current->regs) : "memory"
    );
    UNREACHED;
}
```



## Kernel Exit to User Mode

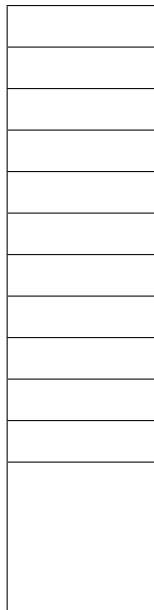

```
void ret_user_iret() {
    handle_hazards();

    asm volatile (
        "lea %0, %%esp;"
        "popa;"
        "pop %%gs;"
        "pop %%fs;"
        "pop %%es;"
        "pop %%ds;"
        "add $8, %%esp;"
        "iret;"
        : : "m" (current->regs) : "memory"
    );
    UNREACHED;
}
```

- Load code segment selector, EIP and flags from stack
- Evaluate RPL of CS from stack
  - $RPL > CPL$ : return to other privilege level
  - otherwise: return to same privilege level
- If privilege level changes
  - Load stack segment selector and ESP from stack
  - Adjust CPL

- Fast ring transition from any ring to ring 0
- Kernel code entry point specified via
  - SYSENTER\_CS\_MSR (code segment)
  - SYSENTER\_EIP\_MSR (entry function)
  - SYSENTER\_ESP\_MSR (kernel stack pointer)
- CPU ...
  - Disables interrupts
  - Loads kernel CS (from SYSENTER\_CS\_MSR)
  - Loads kernel SS (from SYSENTER\_CS\_MSR + 8)
  - Loads kernel ESP (from SYSENTER\_ESP\_MSR)
  - Loads kernel EIP (from SYSENTER\_EIP\_MSR)
  - Does NOT save user return EIP or other user state

- Fast ring transition from any ring to ring 3
- CPU ...
  - Loads user CS (from SYSENTER\_CS\_MSR + 16)
  - Loads user SS (from SYSENTER\_CS\_MSR + 24)
  - Loads user ESP (from ECX)
  - Loads user EIP (from EDX)
  - Enables interrupts

- May, 11th: Exercise 1 (Kernel entry/exit) in **room E067**
- May, 18th: Exercise 2 (Multiboot, ELF) in **room E067**
- May, 25th: Interprocess communication
- June, 1st: Exercise 3 (Thread switching) in **room E067**
- June, 8th: Capabilities
- ...